

The Harman Kardon Model T35C

Manual No.71B

AUTO-LIFT TURNTABLE

Technical Manual

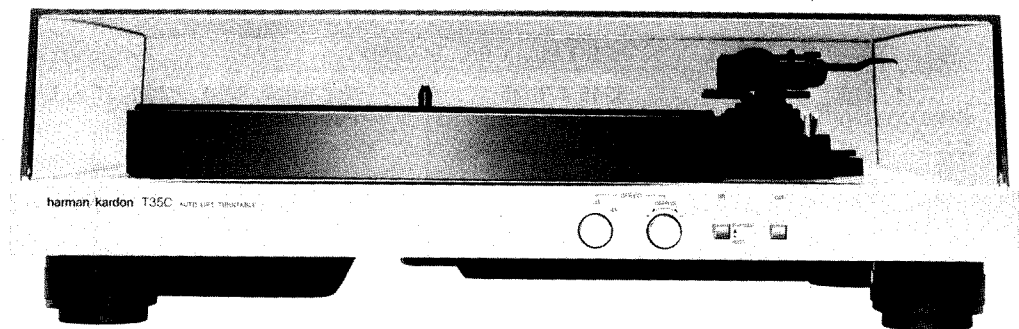

SUPPLEMENTARY MANUAL

THE MODEL T35C IS IDENTICAL TO THE MODEL T35 EXCEPT FOR AN ADDED CUT SWITCH AND OTHER PART CHANGES AS NOTED IN THIS SUPPLEMENT. REFER TO SERVICE MANUAL NO. 71A FOR ALL OTHER PARTS AND SERVICE INFORMATION.

harman/kardon
240 CROSSWAYS PARK WEST, WOODBURY, N.Y. 11797
1112-H15271B3 P-08849 1650 PRINTED IN JAPAN

T35C

GENERAL UNIT PARTS LIST

Ref. No.	Part No.	Description
1	A415-T35CA A415-T35CB	Cabinet Assembly (for U.S.A. & Canada models) Cabinet Assembly (for General model)
2	A443-T35C	Front Panel Assembly
23	914901-2	Foot
39	874045	Bracket

ELECTRICAL PARTS LIST

Ref. No.	Part No.	Description
CHASSIS MISCELLANEOUS		
P2	871474	Output Cord Assembly (for U.S.A. & Canada models)
SW1	915021-1	Micro-Switch, Rest
LUG2	914359-4	Lug Terminal with Lead Wire
PCB-1 MAIN P.C. BOARD		
C216, 217	5345-476-25	Capacitor, 47 μ F, \pm 20%, 25V, Electrolytic
SW204/205	915370	Push Switch, Lift, Cut

SCHEMATIC DIAGRAM

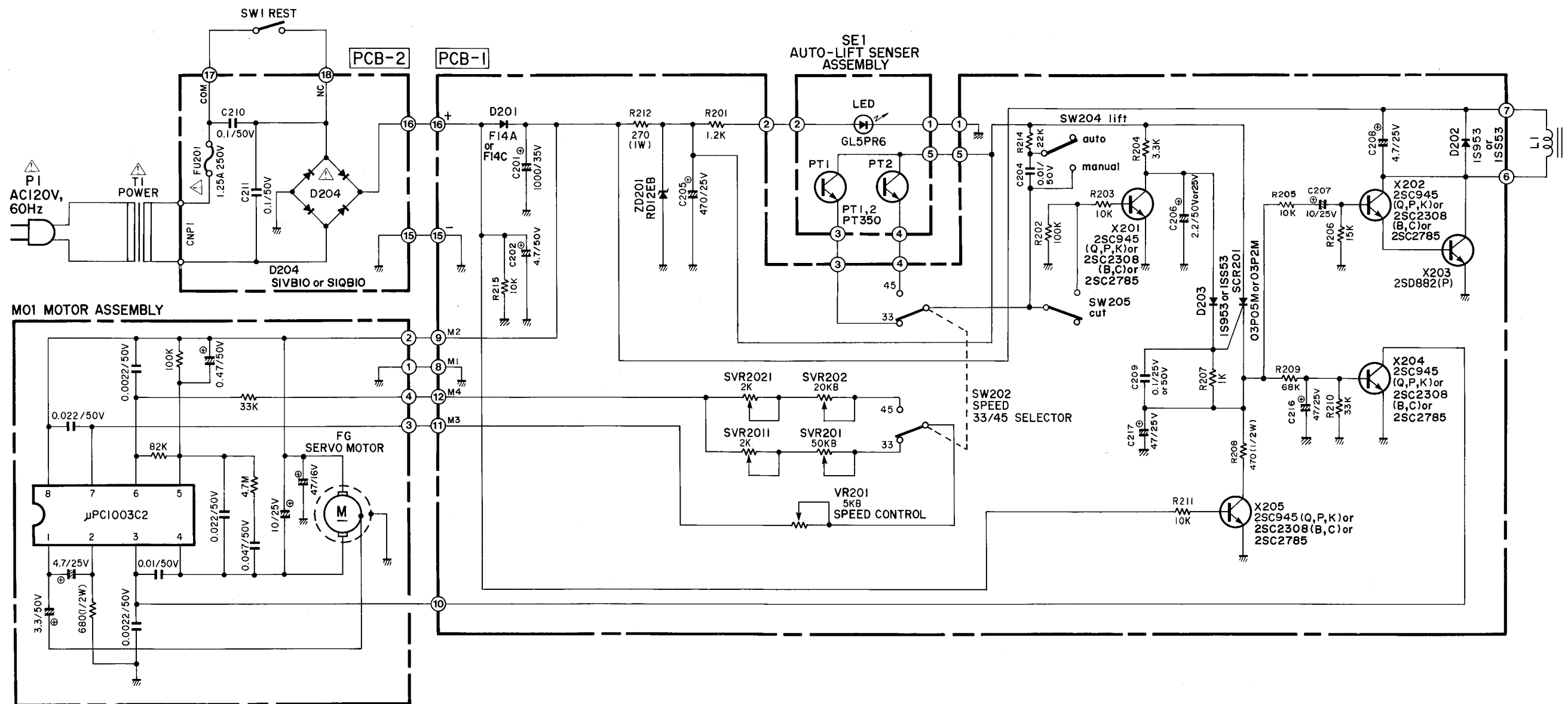
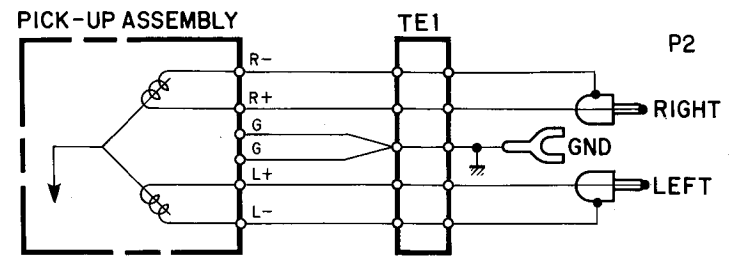
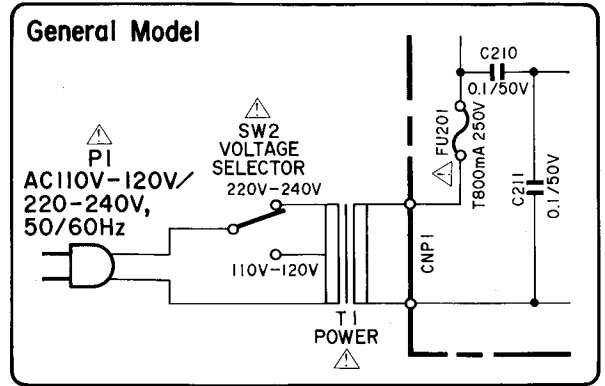

1. ALL RESISTANCES VALUES ARE IN Ω.
kΩ= 1000Ω, MΩ= 1000kΩ
2. THE WATTAGE OF RESISTORS IS 1/4W, UNLESS OTHERWISE NOTED.
3. ALL CAPACITANCES VALUES ARE IN μF UNLESS OTHERWISE NOTED. P = μμF
4. ⚠ SAFETY-REQUIREMENTS COMPONENTS IN ACCORDANCE WITH PRESENT SAFETY REGULATIONS, THESE COMPONENTS MUST ONLY BE REPLACED BY ORIGINAL PARTS.

SCHEMATIC DIAGRAM

General Model

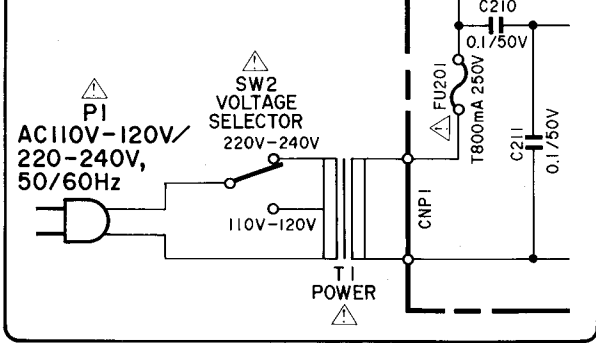

PICK-UP ASSEMBLY

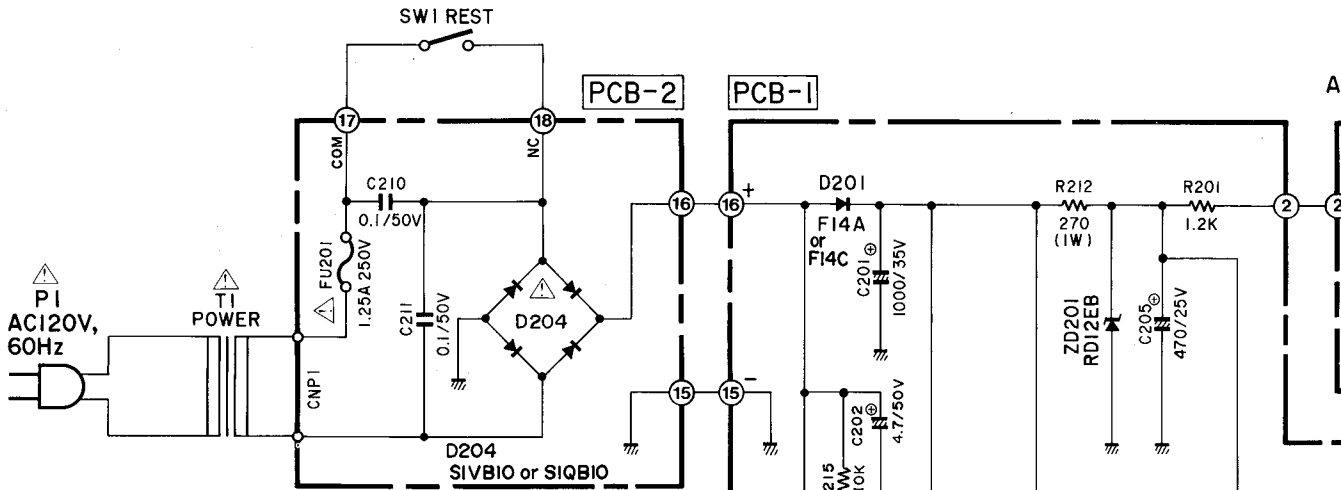
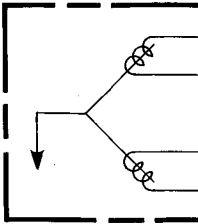

M01 MOTOR ASSEMBLY

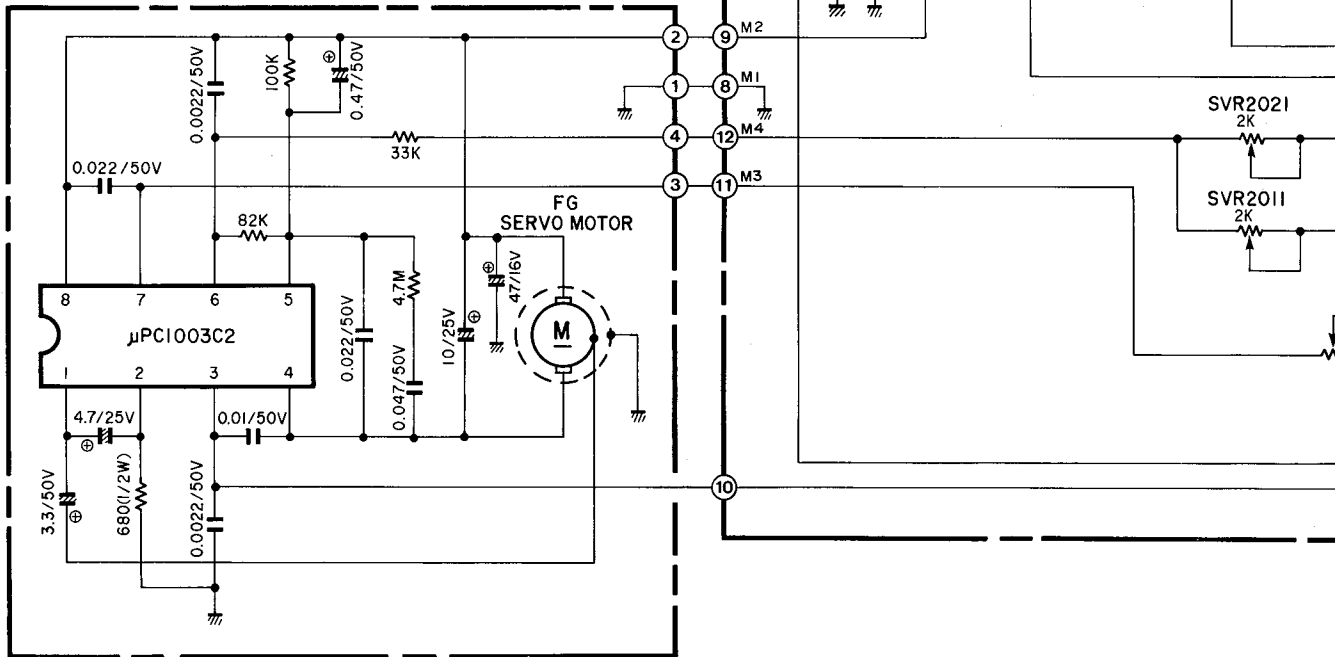

SVR201
2K

SVR2011
2K

E	F	G	H	I	J
---	---	---	---	---	---

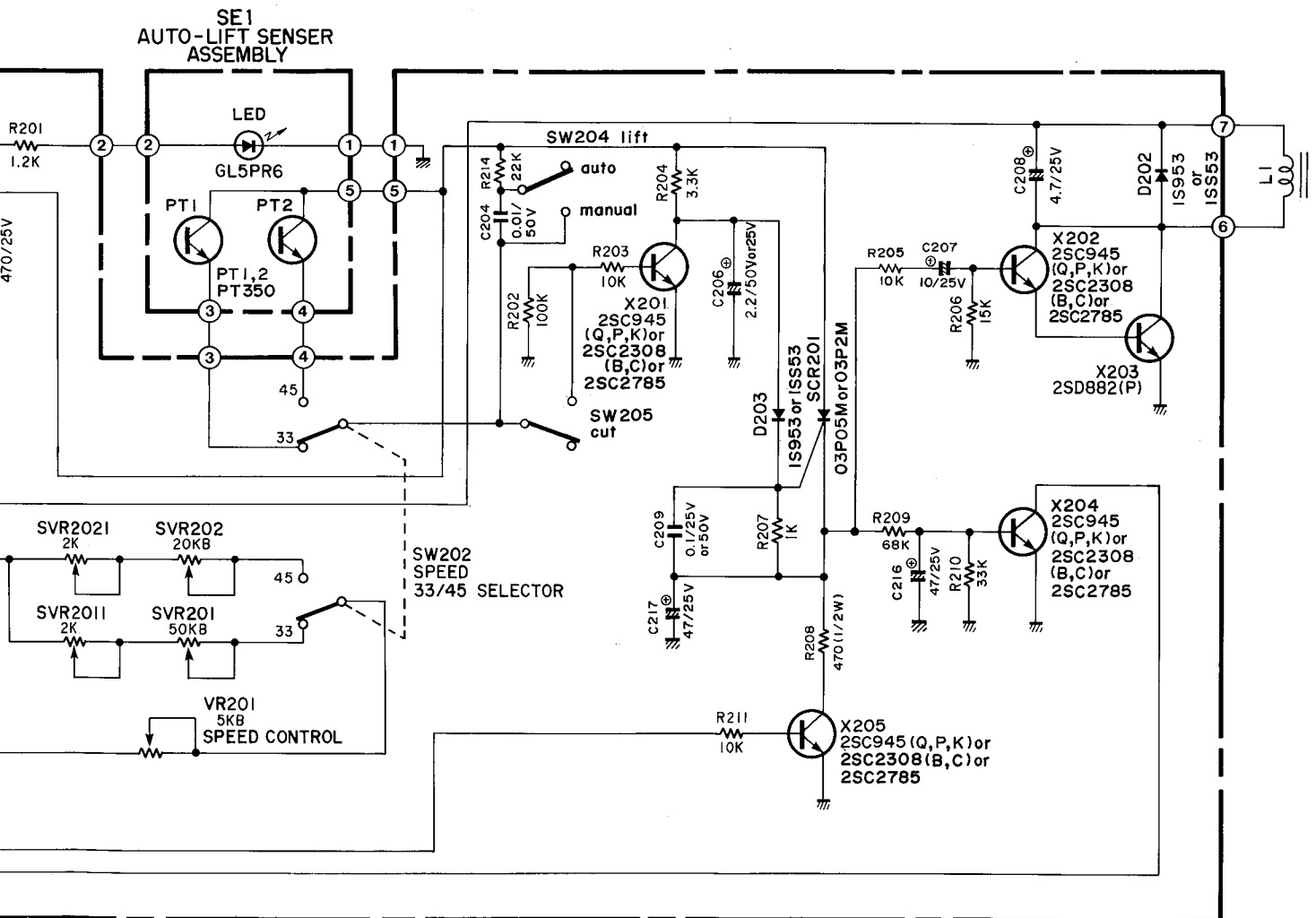
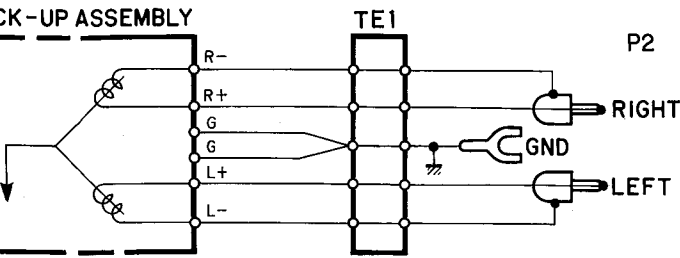

1. ALL RESISTANCES VALUES ARE IN Ω .
k Ω = 1000 Ω , M Ω = 1000k Ω
2. THE WATTAGE OF RESISTORS IS 1/4W, UNLESS OTHERWISE NOTED.
3. ALL CAPACITANCES VALUES ARE IN μ F UNLESS OTHERWISE NOTED. P = μ F
4. SAFETY-REQUIREMENTS COMPONENTS IN ACCORDANCE WITH PRESENT SAFETY REGULATIONS, THESE COMPONENTS MUST ONLY BE REPLACED BY ORIGINAL PARTS.

WIRING DIAGRAM

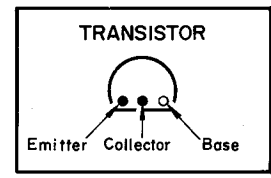
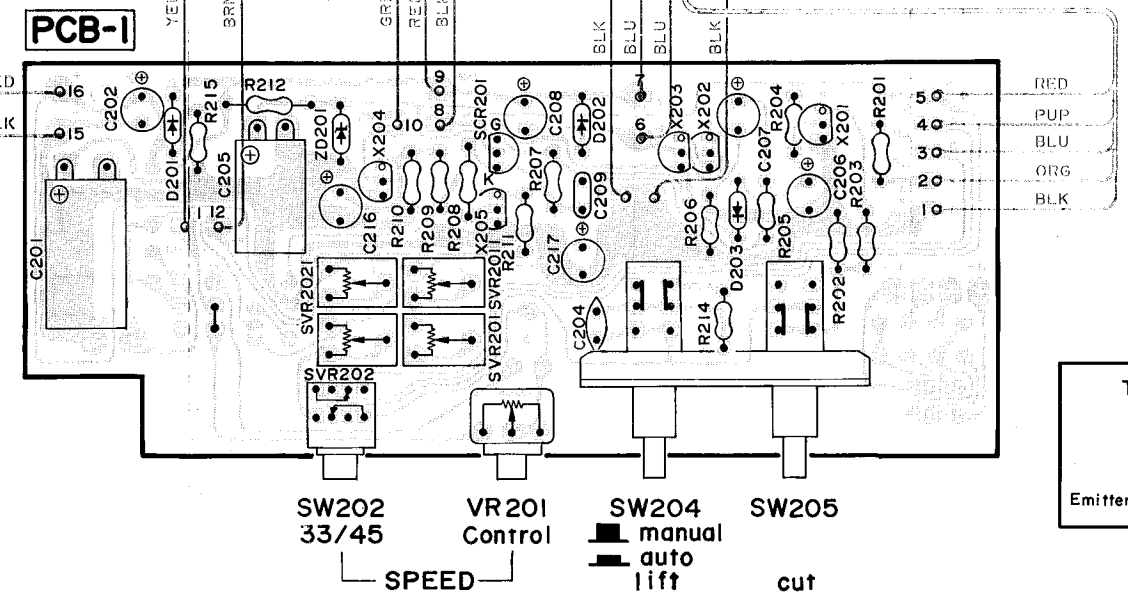
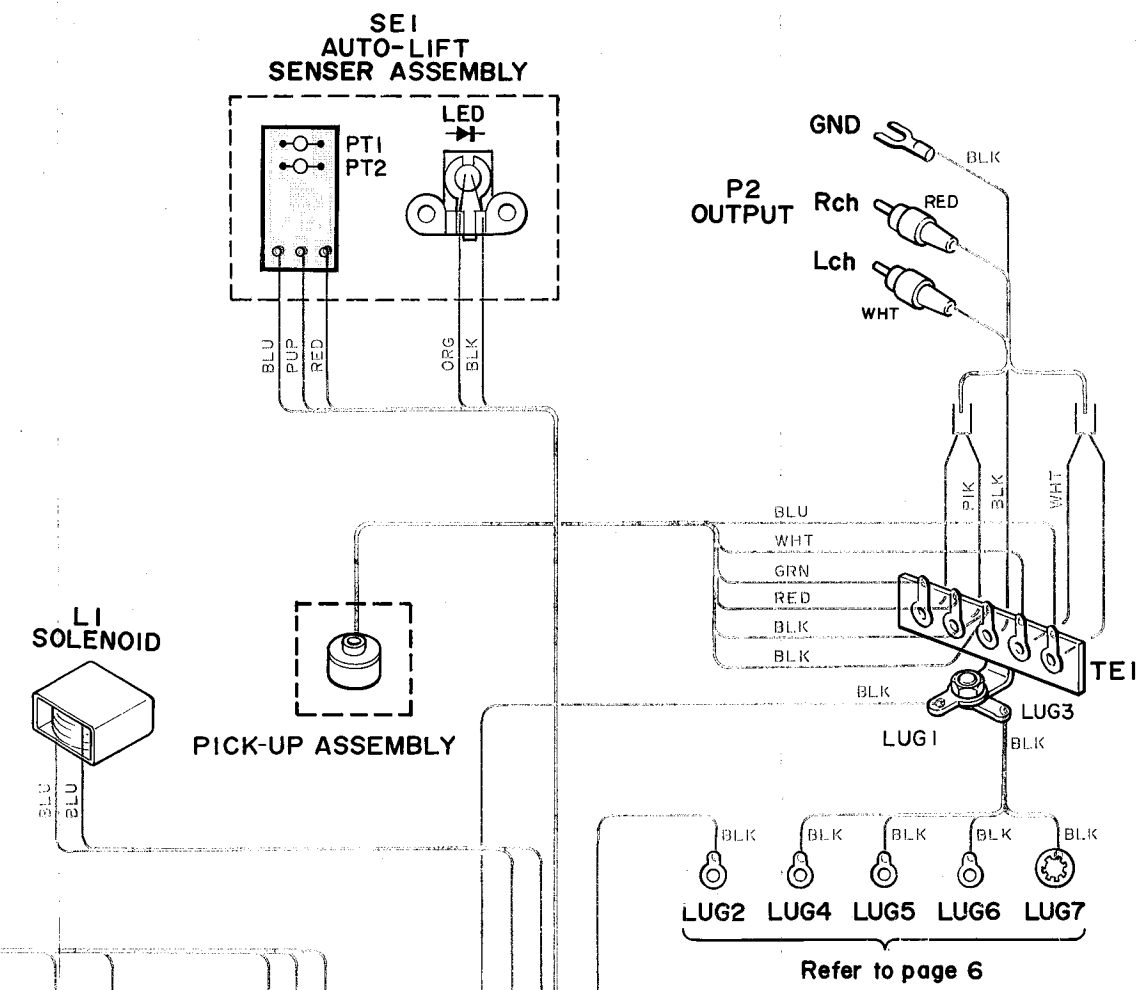
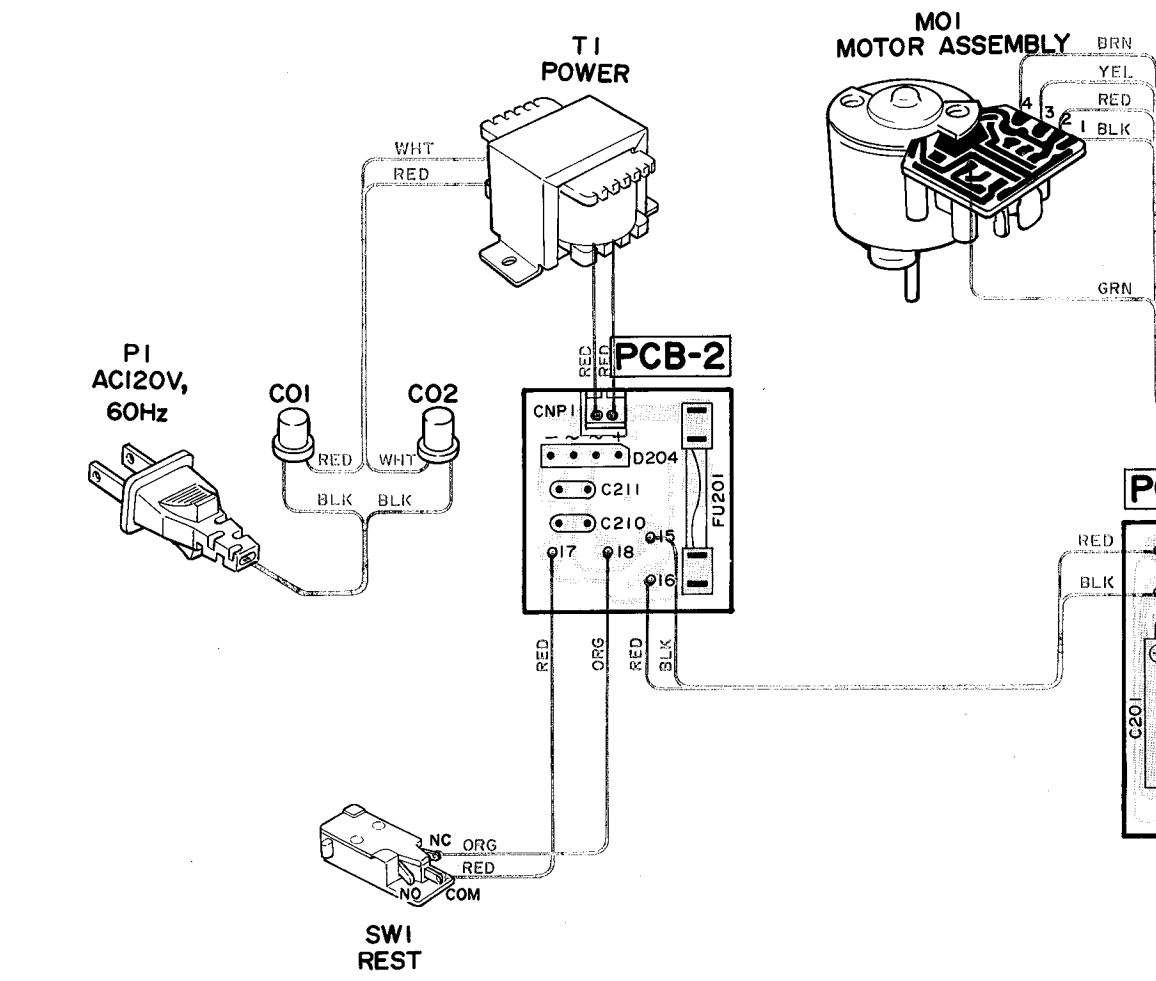
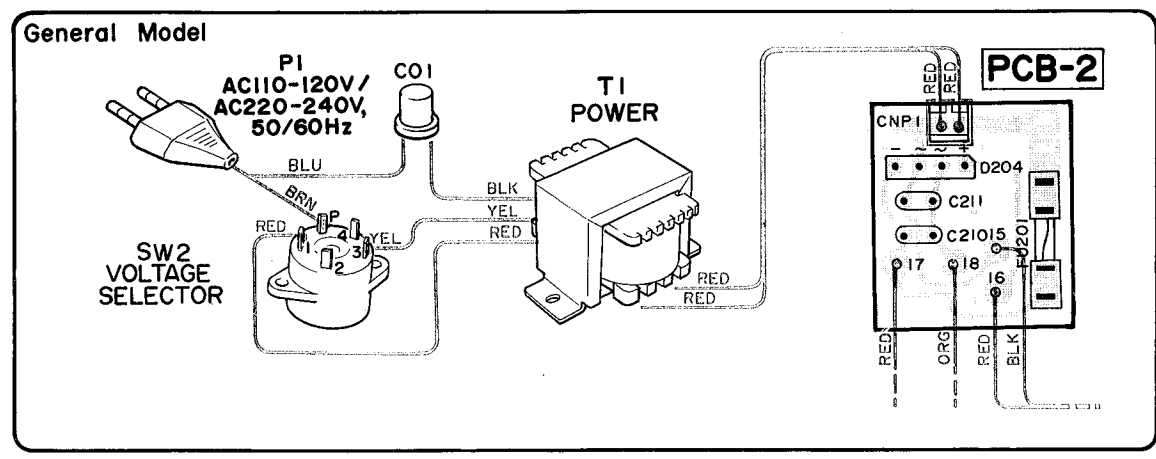

PIN CONNECTION DIAGRAM OF TRANSISTORS AND DIODES.

2SC945(Q) or (P) or (K)	2SD882(P)	GL5PR6	PT350	F14A	1S953, RD12EB3	S1VB10
E C B	E C B	Cathode Anode	C E	Anode Cathode	Anode Cathode	+

WIRE COLOR ABBREVIATIONS

- RED : Red
- ORG : Orange
- BLU : Blue
- WHT : White
- GRN : Green
- BLK : Black
- YEL : Yellow
- PUP : Purple
- PIK : Pink

WIRING DIAGRAM

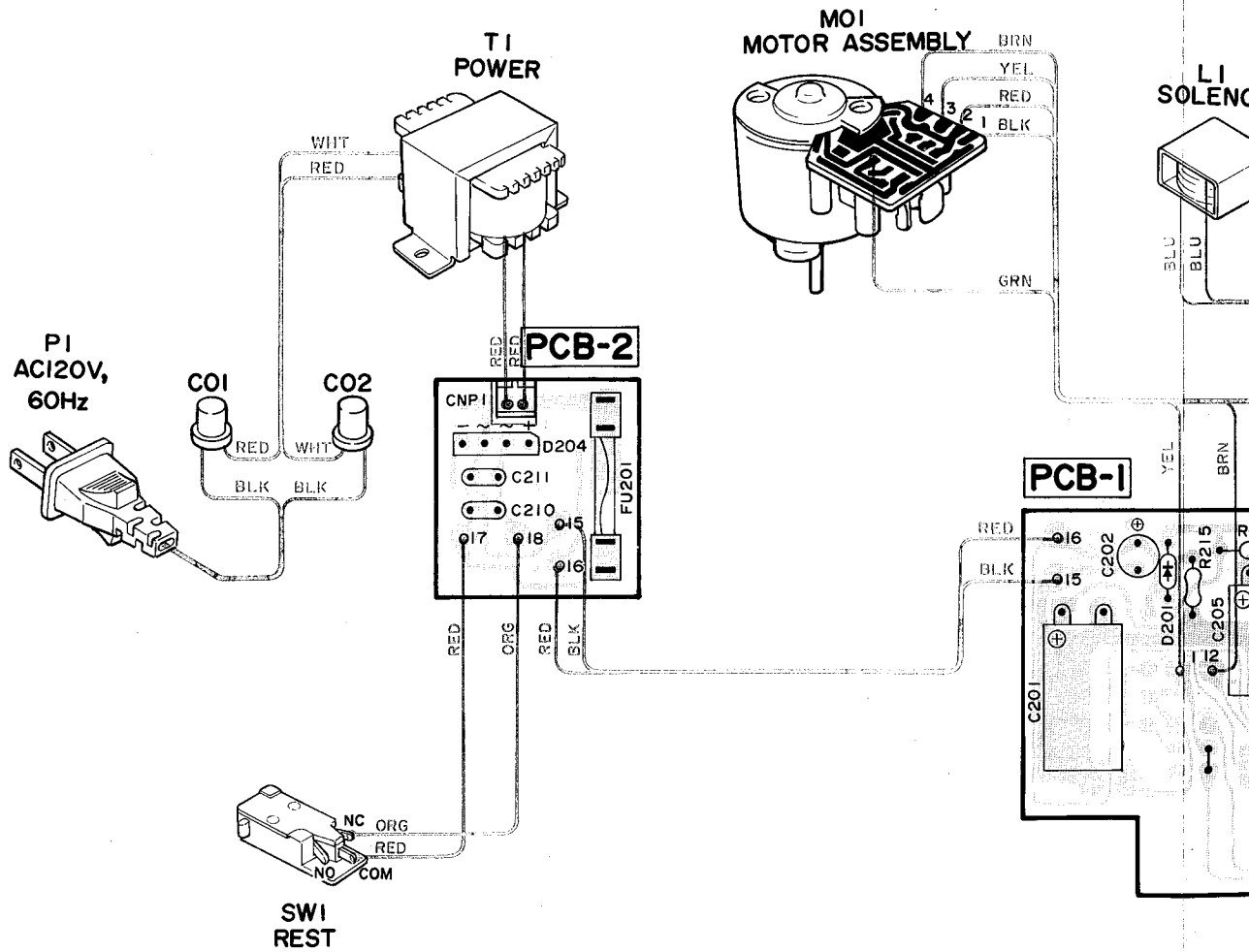
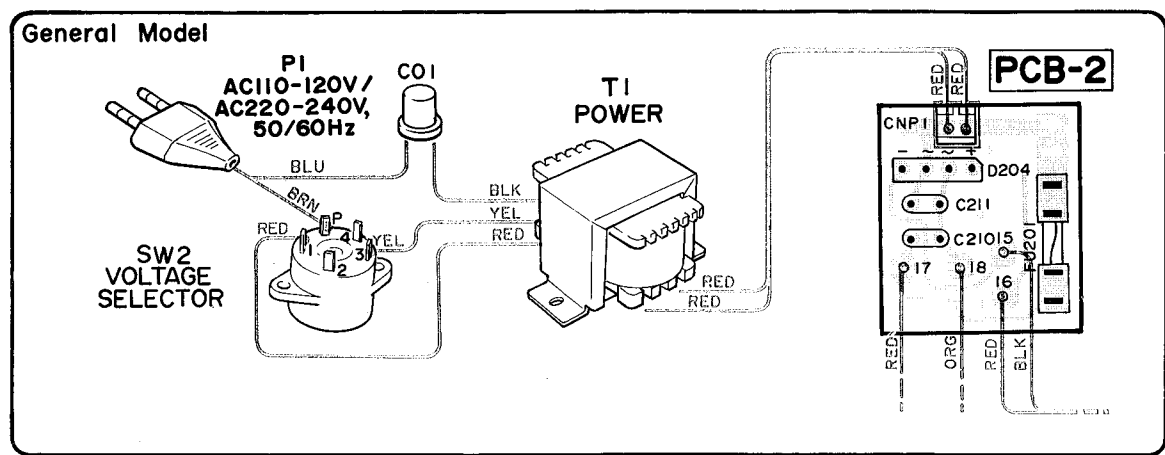

PIN CONNECTION DIAGRAM OF TRANSISTORS AND DIODES.

<p>2SC945(Q) or (P) or (K)</p>	<p>2SD882(P)</p>	<p>GL5PR6</p> <p>Cathode</p> <p>Anode</p>	<p>PT350</p>	<p>F14A</p> <p>Anode</p> <p>Cathode</p>	<p>1S953, RD12EB3</p> <p>Anode</p> <p>Cathode</p>	<p>S1VB10</p>
--------------------------------	------------------	---	--------------	---	---	---------------

**SE1
AUTO-LIFT
SENER ASSEMBLY**

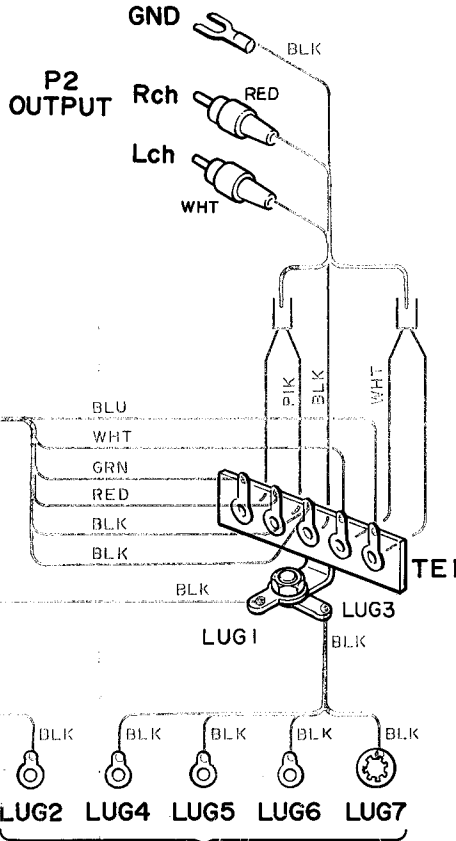
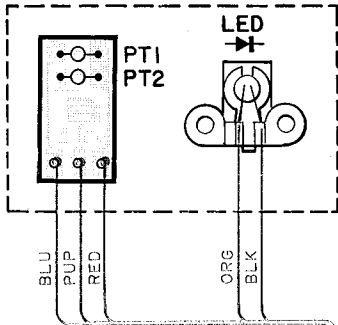

**LI
SOLENOID**

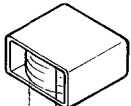

PICK-UP ASSEMBLY

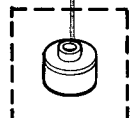

Refer to page 6

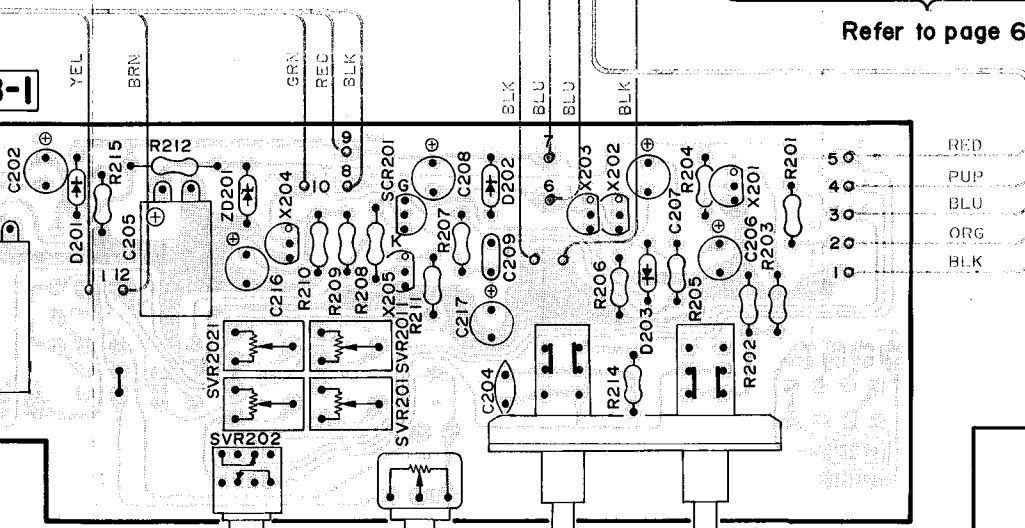

SW202
33/45

VR201
Control

SW204
manual
auto
lift

SW205
cut

SPEED

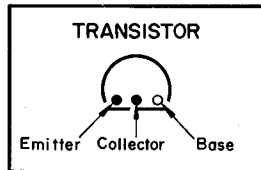

• WIRE COLOR ABBREVIATIONS

- RED : Red
- ORG : Orange
- BLU : Blue
- WHT : White
- GRN : Green
- BLK : Black
- YEL : Yellow
- PUP : Purple
- PIK : Pink